

YDS-IRSW-OS05A20 V3.0

5MP OS05A20 IR Switch MIPI Interface M12 Fixed Focus Camera Module

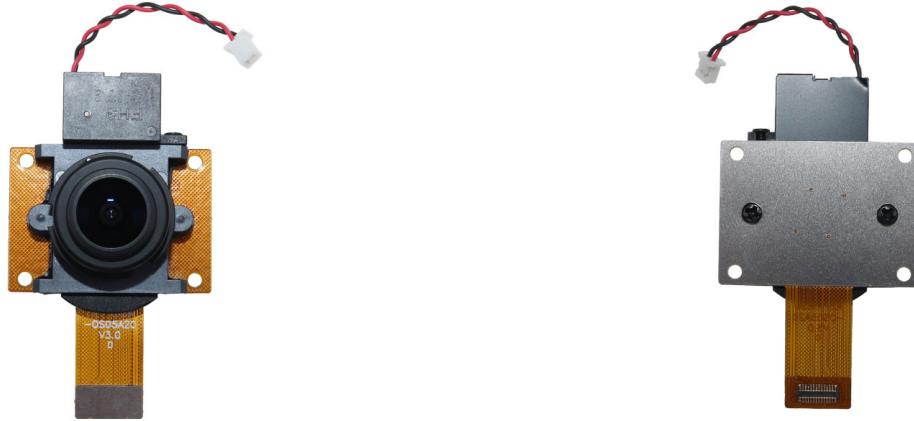

Camera Module No.	YDS-IRSW-OS05A20 V3.0
Resolution	5MP
Image Sensor	OS05A20
Sensor Type	1/2.7"
Pixel Size	2.0 um x 2.0 um
EFL	1.95 mm
F.NO	2.20
Pixel	2688 x 1944
View Angle	180.0°(DFOV) 171.5°(HFOV) 118.0°(VFOV)
Lens Dimensions	22.20 x 21.50 x 12.96 mm
Module Size	50.00 x 30.00 mm
Module Type	Fixed Focus
Lens Model	YDS-LENS-E3335C
IR Switch Input Voltage	3.3V - 5.5V
Lens Filter IR Frequency	645nm +/- 15nm
Lens Filter AR Frequency	700nm - 1,000nm
Operation (IR Day Time)	Red Line: Negative Black Line: Positive
Operation (AR Night Time)	Red Line: Positive Black Line: Negative
IR Switch Connector	962-10231-030005 (2 Pin)
Interface	MIPI
Operating Temperature	-30°C to +85°C
Mating Connector	WP7A-S024VA1



YDS-IRSW-OS05A20 V3.0

5MP OS05A20 IR Switch MIPI Interface M12 Fixed Focus Camera Module



Top View



Side View

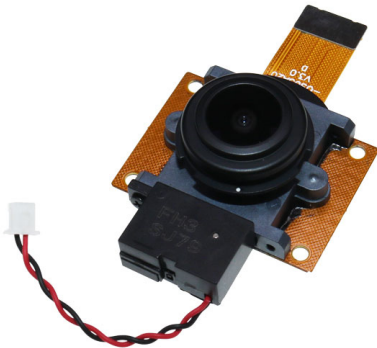

Bottom View

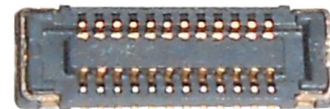

Mating Connector

ROHS

PIN SIGNAL

1	AGND
2	AVDD2.8V
3	SDA
4	SCL
5	PWDN
6	RST/XSHUNDN
7	MCP
8	MCN
9	DGND
10	MDP0
11	MDN0
12	DGND
13	MDP1
14	MDN1
15	DGND
16	MDP2
17	MDN2
18	DGND
19	MDP3
20	MDN3
21	DGND
22	DVDD1.2V
23	DVDD1.8V
24	MCLK

Parameter:

1、Sensor specification:

Image Sensor: OS05A20
 Pixel: 2umx2um
 Lens Type: 1/2.7
 Important Voltage Description: DVDD1.2V
 (external power supply);

2、Lens specification:

FOV: 180°(D),171.5°(H),118°(V)
 F/NO.: 2.2
 OP distortion: <-9%
 Focal length: 1.95mm
 Composition: 6G+IR Switch

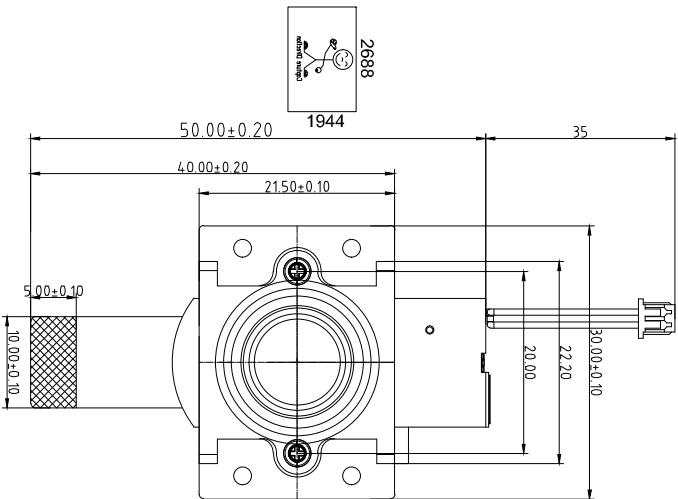

TOP VIEW

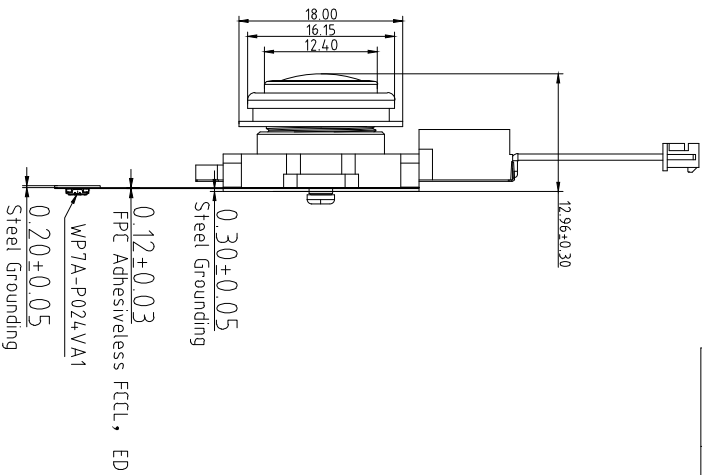

SIDE VIEW

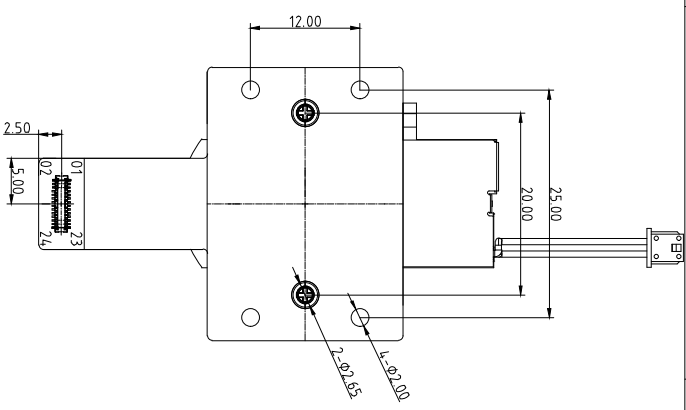

BOTTOM VIEW

NOTE:
 1.The device slave
 address:0x6C(w),0x6D(r)

Version Mark	Information	Date
V1.0	PD First Version	2019-03-23
V2.0	Connector changed	2019-03-23
V3.0	Change lens and IR CUT	2019-10-29

3

2

Designed By

Kevin

Model Name:

IRS-W-OS05A20 V3.0

Unit: mm

Checked By

Aouly

Projection Type:

Third Angle

Scale:

1:1

Sheet:

1 of 1

Version:

1/0

3

2

1

2

1

3

2

1

2

1

3

2

1

2

1

3

2

1

2

1

3

2

1

2

1

3

2

1

2

1

3

2

1

2

1

3

2

1

2

1

3

2

1

2

1

3

2

1

2

1

3

2

1

2

1

3

2

1

2

1

3

2

1

2

1

3

2

1

2

1

3

2

1

2

1

3

2

1

2

1

3

2

1

2

1

3

2

1

2

1

3

2

1

2

1

3

2

1

2

1

3

2

1

2

1

3

2

1

2

1

3

2

1

2

1

3

2

1

2

1

3

2

1

2

1

3

2

1

2

1

3

2

1

2

1

3

2

1

2

1

3

2

1

2

1

3

2

1

2

1

3

2

1

2

1

3

2

1

2

1

3

2

1

2

1

3

2

1

2

1

3

2

1

2

1

3

2

1

2

1

3

2

1

2

1

3

2

1

2

1

3

2

1

2

1

3

2

1

2

1

3

2

1

2

1

3

2

1

2

1

3

2

1

2

1

3

2

1

2

1

3

2

1

2

1

3

2

1

2

1

3

2

1

2

1

3

2

1

2

1

3

2

1

2

1

3

2

1

2

1

3

2

1

2

1

3

2

1

2

1

3

2

1

Real Test Images

IRSW-OS05A10 V3.0

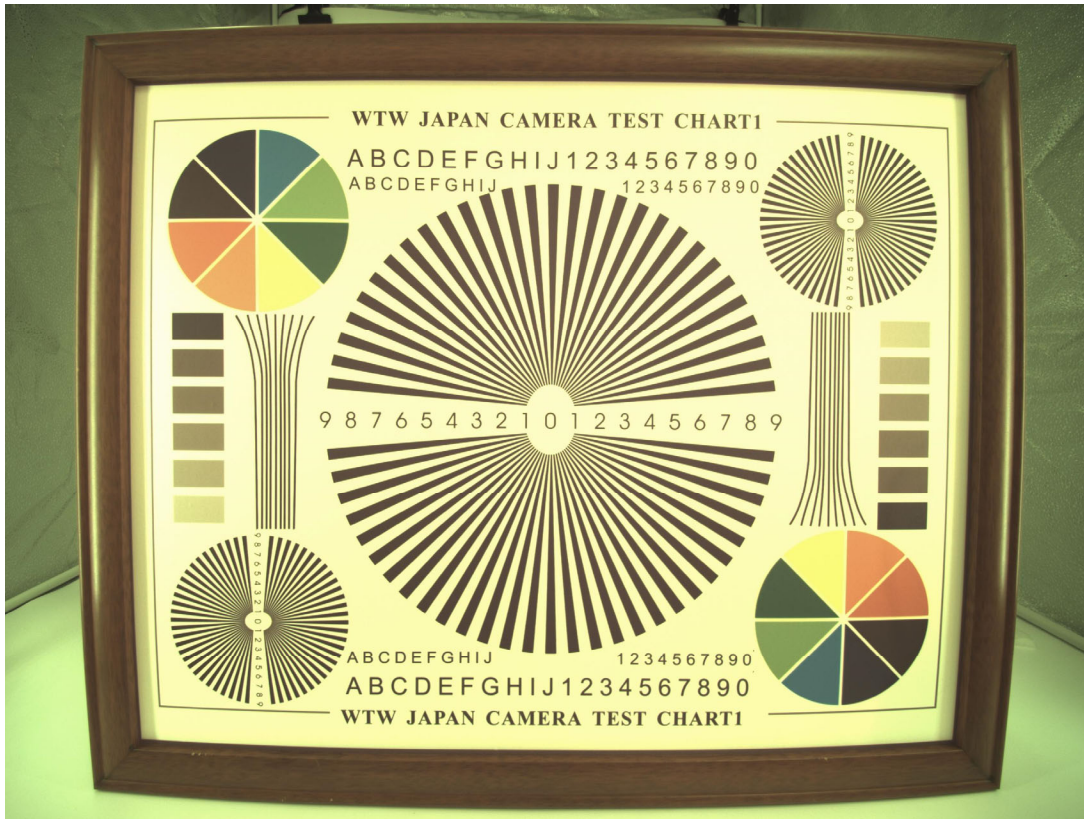

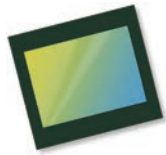

OS05A20 5-megapixel product brief



available in
a lead-free
package

New OS05A20 Uses Nyxel® Technology to Bring Superior Image Quality to Video Surveillance Cameras Day or Night

The 5-megapixel OS05A20 is the world's first image sensor to implement Nyxel® technology, OmniVision's breakthrough near-infrared (NIR) technology that allows image sensors to see better and farther under low- and no-light conditions. By using Nyxel® technology and a 2 x 2 micron pixel, the OS05A20 PureCel® image sensor has the unique ability to capture high-quality, high-resolution day or night, making it ideally suited for professional surveillance systems.

Nyxel® technology combines thick-silicon pixel architectures with extended deep trench isolation (DTI) to improve quantum efficiency (QE) up to 3x for 850 nm sensitivity and up to 5x for 940 nm sensitivity, while

maintaining all other image-quality metrics. These improvements deliver unrivaled image quality, extended image-detection range and a reduced light-source requirement, leading to lower power consumption.

Available in a 1/2.7-inch optical format, the OS05A20 is capable of capturing full-resolution 2688 x 1944 video at 60 frames per second (fps), 1080p full high definition (HD) video at 120 fps, and 720p HD video at 180 fps. The sensor comes in a chip scale package (CSP).

Find out more at www.ovt.com.



Applications

- Security Cameras
- High Resolution Consumer Cameras
- Action Cameras

Product Features

- $2\ \mu\text{m} \times 2\ \mu\text{m}$ pixel
- optical size of 1/2.7"
- QE enhancement in 850 nm and 940 nm
- programmable controls for:
 - frame rate
 - mirror and flip
 - cropping
 - windowing
- supports output formats:
 - 12-/10-bit RAW RGB
- supports images sizes:
 - 2688 x 1944
 - 1080p (1920x1080)
 - 720p (1280x720)
- supports 2x2 binning
- standard serial SCCB interface
- 12/10-bit ADC
- up to 4-lane MIPI/LVDS serial output interface (supports maximum speed up to 1500 Mbps/lane)
- 2-exposure staggered HDR support
- programmable I/O drive capability
- light sensing mode (LSM)
- PLL with SCC support
- support for frame sync

OS05A20



Ordering Information

- OS05A20-H73A-1B (color, lead-free) 73-pin CSP
- OS05A20-H73A-1C (color, lead-free) 73-pin CSP

Technical Specifications

- active array size: 2688 x 1944
- maximum image transfer rate:
 - 2688 x 1944: 60 fps
 - 2688 x 1520: 60 fps
- power supply:
 - core: 1.2V
 - analog: 2.8V
 - I/O: 1.8V
- power requirements:
 - active: 210 mW
 - standby: 2 mA
 - XSHUTDOWN: 2 μA
- temperature range:
 - operating: -30°C to +85°C junction temperature
 - stable image: 0°C to +60°C junction temperature
- output formats: 10/12-bit RGB RAW
- lens size: 1/2.7"
- lens chief ray angle: 11° linear
- scan mode: progressive
- pixel size: 2.0 $\mu\text{m} \times 2.0\ \mu\text{m}$
- image area: 5434.56 $\mu\text{m} \times 3948.05\ \mu\text{m}$

Functional Block Diagram

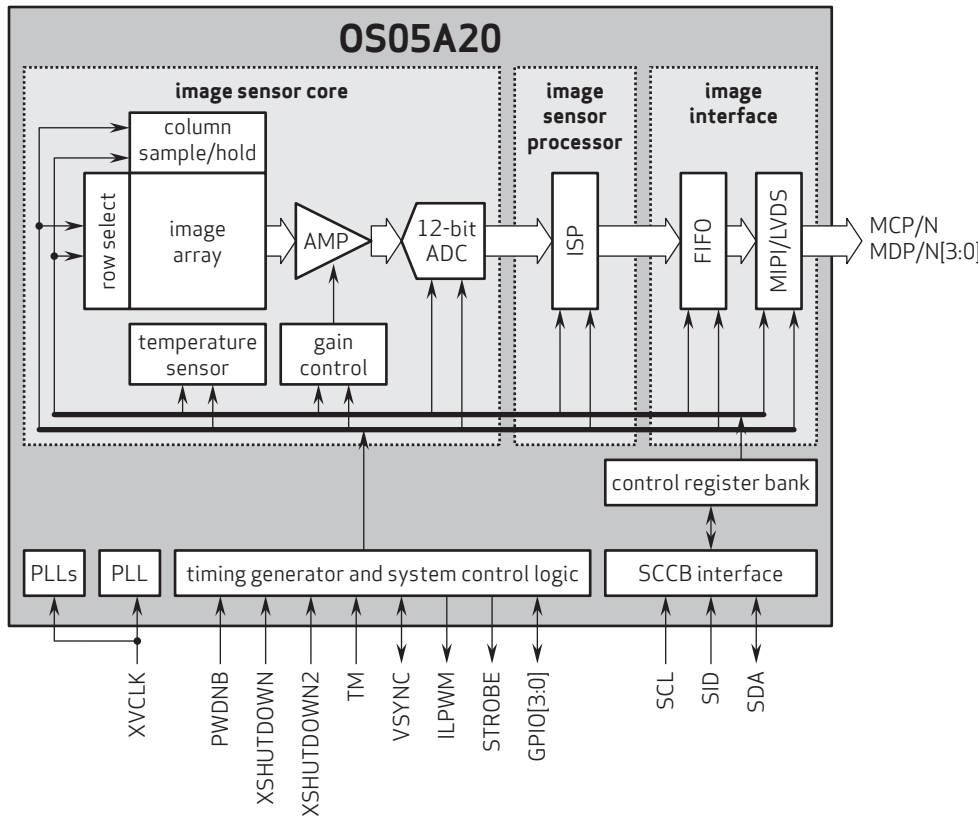

4275 Burton Drive
Santa Clara, CA 95054
USA

Tel: + 1 408 567 3000
Fax: + 1 408 567 3001
www.ovt.com

OmniVision reserves the right to make changes to their products or to discontinue any product or service without further notice. OmniVision, the OmniVision logo, PureCel, and Nixel are registered trademarks of OmniVision Technologies, Inc. All other trademarks are the property of their respective owners.



OmniVision

YDS-LENS-E3335C

SPECIFICATION SHEET									
Material No. 物料号		/							
传感器规格 Sensor Spec		CCD/CMOS							
最大像面		Ø5.6mm							
Max Image Circle		1.95mm							
EFL 有效焦距		F2.2							
FNo. F值		OS05A20							
F.O.V. 视场角		D.水平 180°(5.57mm) H.垂直 171.5°(5.376mm)							
Back Focal Length 后截距		V.垂直 3.07mm (0.3mm filler +0.4 cover glass)							
Lens Effective Diameter 通光口径		Front Ø9.4mm Back Ø6mm							
Lens construction 镜头组成		6-5(ASG)							
OP Distortion 光学畸变		-9%							
Resolution 分辨率		Mega pixel							
Relative Illumination 相对照度		≥40%							
Iris 光圈		Fixed							
Max Chief Ray Angle 最大主光线入射角		15.6±3°							
Min.O.D 最近物距		0.1m							
Working Distance 工作物距		∞							
Mount 接口		M12X0.5							
TTL 光学总长		12.5±0.2mm (0.3mm filler +0.4 cover glass)							
Dimension (ØxL) 外形尺寸		Ø18x12.5							
Filter Spec 滤光片规格		/							

Image Circle vs. Sensor Format

REV. NO.	DATE	DESCRIPTION	REVISED	APPR.	APPR.	NAME	DATE
00	2019.6.30	新规范作成	HLQ	XLL	AUDI.		

UNLESS TOLERANCE Single Part Size: 0.1 Portfolio Size: 0.3 3RD Angle Projection

NEW



0.4mm Pitch, Stacking Type
Board-to-Board (FPC) Connector

CONNECTOR

MB-0228-3

September 2017

WP7 Series

RoHS Compliant

Plug

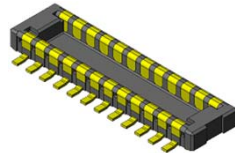

Plug

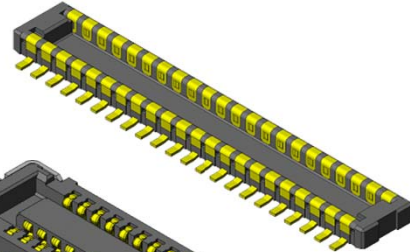

Receptacle

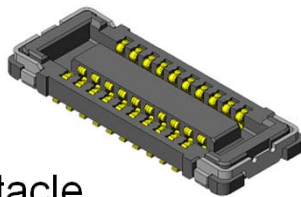

Receptacle

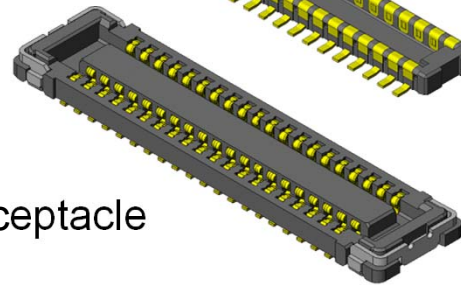

The WP7 Series is a low-profile board-to-board (FPC) connector with 0.4mm pitch spacing that is ideal for high-density mounting in slim information communication devices like mobile phones, smartphones, LCD, and notebook PC.

To satisfy different product function requirements, a low pin count type and a high pin count type (WP7A / WP7B) are available with the same mounting pattern.

Features

- 0.4mm pitch, 2 rows, 0.7mm stacking height.
- Contact structure ensures high wear-resistance and high contact reliability.
- Secure hold-downs prevent insulator breakage and peeling from FPC.
- 2-point contact design to resist twisting stress.
- Pb-free (Ni barrier on contact prevents solder wicking.)
- Receptacle contacts adopt an optimal configuration according to the pin counts.
High removal force WP7A (low pin count: 10-32 pos.)
Low insertion force WP7B (high pin count 34-70 pos.)
- Signal contact supports 10 Gbps transmission rate.
- Supports MIPI, USB3.1 Gen2, and PCIe Gen3 transmission.

General Specifications

- | | |
|---|---|
| <ul style="list-style-type: none"> ■(WP7A) No. of Contacts:
10, 16, 20, 22, 24, 26,
28, 30, 32 pos. ■(WP7B) No. of Contacts:
34, 40, 50, 60, 70 pos. ■Pitch: 0.4mm, 2 rows ■Operating Temperature:
-40 Deg. C to +85 Deg. C ■Contact Resistance:
70mΩ max. (initial) ■Life Time: 30 mating cycles | <ul style="list-style-type: none"> ■Rated Current: AC, DC 0.3A each per terminal ■Rated Voltage: AC, DC 50V ■Insulation Resistance: 100MΩ min. (initial) ■Dielectric Withstanding Voltage:
AC250Vr.m.s for 1 minute ■(WP7A) total insertion force:
1.50N x n max. (n: No. of pos.) ■(WP7A) total removal force:
0.15N x n min. (n: No. of pos.) ■(WP7B) total insertion force:
1.00N x n max. (n: No. of pos.) ■(WP7B) total removal force:
0.10N x n min. (n: No. of pos.) |
|---|---|

Materials and Finishes

Component	Material / Finish
Contact	Cu alloy / Au plating
Insulator	Heat-resistant plastic
Hold-Down	Plug: Cu alloy / Au plating Receptacle: Cu alloy / Sn plating

Ordering Information (Plug)

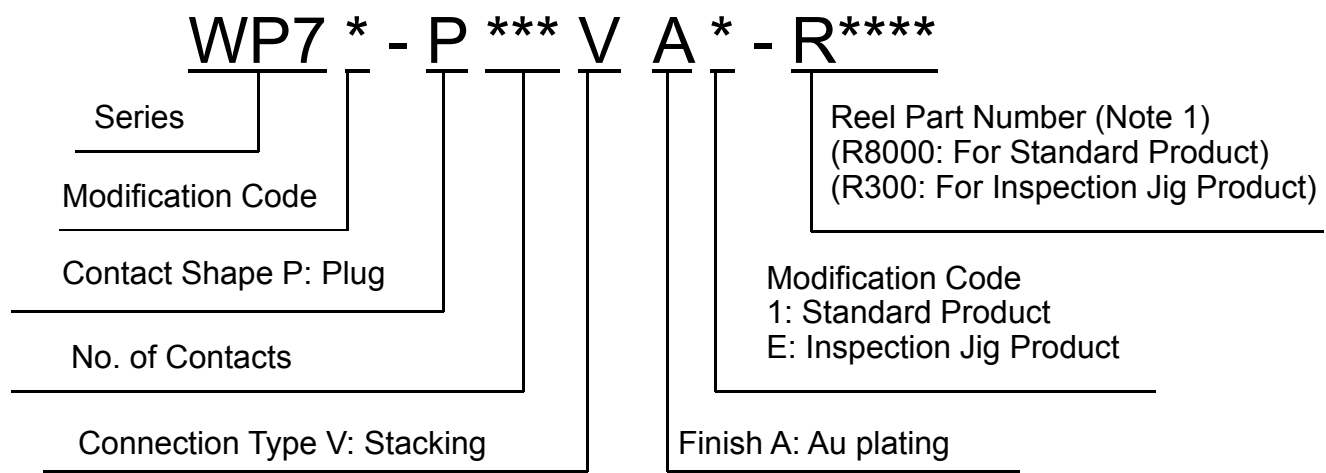

Ordering Information (Receptacle)

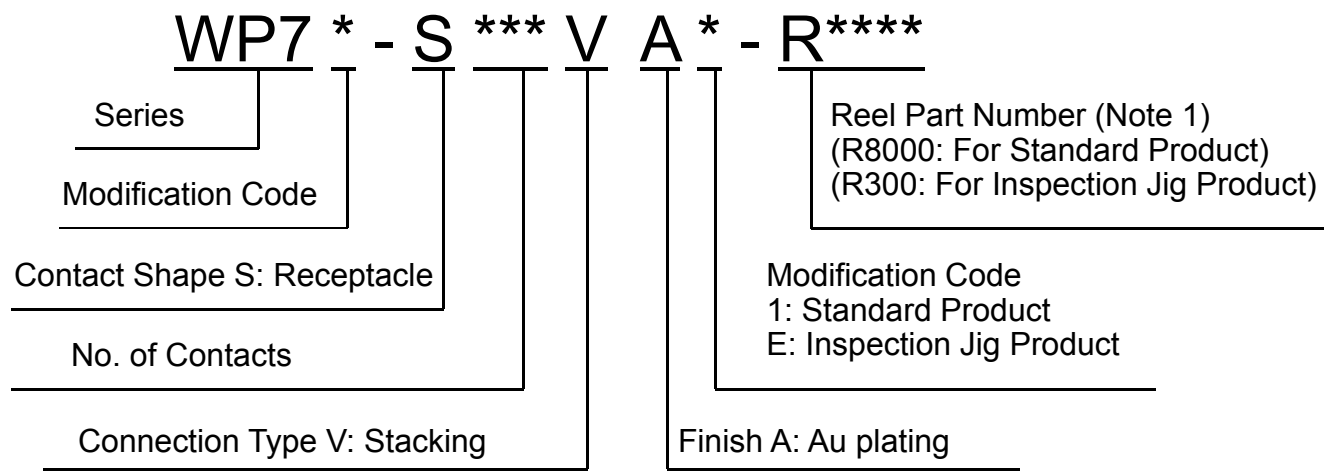

Note 1) An embossed tape reel contains 8,000 pieces of standard product, or 300 pieces of inspection jig product.
Please contact us for details on embossed tape specifications.

Part Number	WP7A-S***VA1
SJ Drawing	SJ111877

WP7A Receptacle

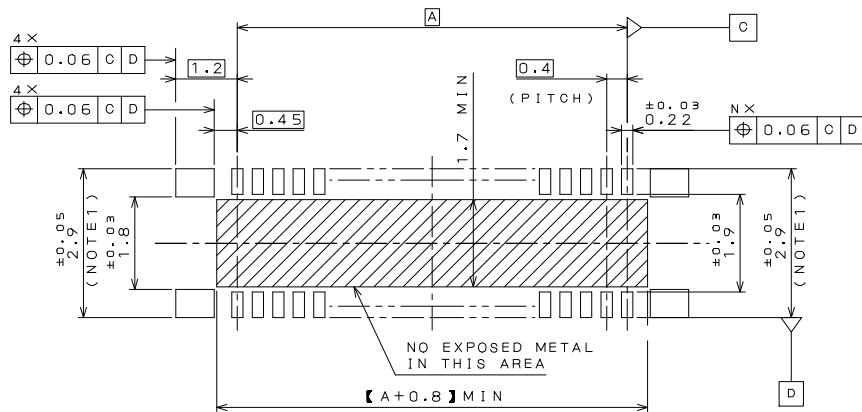
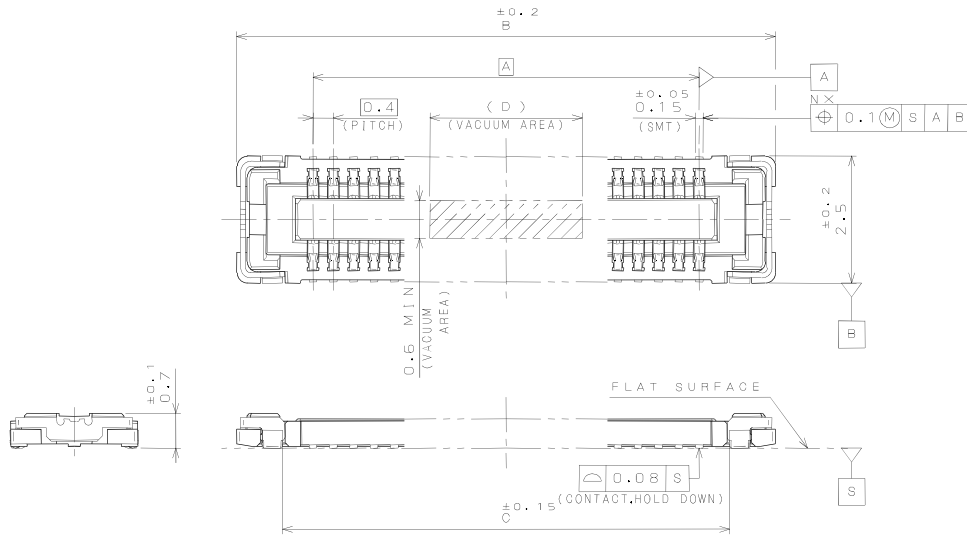

APPLICABLE P.C.B. DIMENSION (REF.)
適合基板寸法 (参考)

DIMENSIONS 寸法 NUMBER OF CONTACT 芯数	DIMENSIONS			
	A	B	C	D
10	1.6	4.6	2.8	2.0
16	2.8	5.8	4.0	2.0
20	3.6	6.6	4.8	2.0
22	4.0	7.0	5.2	2.0
24	4.4	7.4	5.6	2.0
26	4.8	7.8	6.0	5.0
28	5.2	8.2	6.4	5.0
30	5.6	8.6	6.8	5.0
32	6.0	9.0	7.2	5.0

Note 1) Dimension 3.5 ± 0.05 is recommended in case repair is needed.



YDS CAMERA MODULE

your best camera partner

Camera Module Pinout Definition Reference Chart

OmniVision	Sony	Samsung	On-Semi	Aptina	Himax	GalaxyCore	PixArt	SmartSens	Sensors
Pin Signal		Description							
DGND	GND								ground for digital circuit
AGND									ground for analog circuit
PCLK	DCK								DVP PCLK output
XCLR	PWDN	XSHUTDOWN	STANDBY						power down active high with internal pull-down resistor
MCLK	XVCLK	XCLK	INCK						system input clock
RESET	RST								reset active low with internal pull-up resistor
NC	NULL								no connect
SDA	SIO_D	SIOD							SCCB data
SCL	SIO_C	SIOC							SCCB input clock
VSYN	XVS	FSYN							DVP VSYNC output
HREF	XHS								DVP HREF output
DOVDD									power for I/O circuit
AFVDD									power for VCM circuit
AVDD									power for analog circuit
DVDD									power for digital circuit
STROBE	FSTROBE								strobe output
FSIN									synchronize the VSYNC signal from the other sensor
SID									SCCB last bit ID input
ILPWM									mechanical shutter output indicator
FREX									frame exposure / mechanical shutter
GPIO									general purpose inputs
SLASEL									I2C slave address select
AFEN									CEN chip enable active high on VCM driver IC
MIPI Interface									
MDN0	DN0	MD0N	DATA_N	DMO1N					MIPI 1st data lane negative output
MDP0	DP0	MD0P	DATA_P	DMO1P					MIPI 1st data lane positive output
MDN1	DN1	MD1N	DATA2_N	DMO2N					MIPI 2nd data lane negative output
MDP1	DP1	MD1P	DATA2_P	DMO2P					MIPI 2nd data lane positive output
MDN2	DN2	MD2N	DATA3_N	DMO3N					MIPI 3rd data lane negative output
MDP2	DP2	MD2P	DATA3_P	DMO3P					MIPI 3rd data lane positive output
MDN3	DN3	MD3N	DATA4_N	DMO4N					MIPI 4th data lane negative output
MDP3	DP3	MD3P	DATA4_P	DMO4P					MIPI 4th data lane positive output
MCN	CLKN	CLK_N	DCKN						MIPI clock negative output
MCP	CLKP	MCP	CLK_P	DCKN					MIPI clock positive output
DVP Parallel Interface									
D0	DO0	Y0							DVP data output port 0
D1	DO1	Y1							DVP data output port 1
D2	DO2	Y2							DVP data output port 2
D3	DO3	Y3							DVP data output port 3
D4	DO4	Y4							DVP data output port 4
D5	DO5	Y5							DVP data output port 5
D6	DO6	Y6							DVP data output port 6
D7	DO7	Y7							DVP data output port 7
D8	DO8	Y8							DVP data output port 8
D9	DO9	Y9							DVP data output port 9
D10	DO10	Y10							DVP data output port 10
D11	DO11	Y11							DVP data output port 11

www.YDSCAM.com sales@ydscam.com Phone (WeChat, QQ): (+86) 177 2732 6718

All rights reserved @ YingDeShun Co. Ltd. Specifications subject to change without notice.

Cameras Applications



IMAGING DEVICES



Camera Reliability Test

Reliability Inspection Item		Testing Method	Acceptance Criteria	
Category	Item			
Environmental	Storage Temperature	High 60°C 96 Hours	Temperature Chamber	No Abnormal Situation
		Low -20°C 96 Hours	Temperature Chamber	No Abnormal Situation
	Operation Temperature	High 60°C 24 Hours	Temperature Chamber	No Abnormal Situation
		Low -20°C 24 Hours	Temperature Chamber	No Abnormal Situation
	Humidity	60°C 80% 24 Hours	Temperature Chamber	No Abnormal Situation
	Thermal Shock	High 60°C 0.5 Hours Low -20°C 0.5 Hours Cycling in 24 Hours	Temperature Chamber	No Abnormal Situation
Physical	Drop Test (Free Falling)	Without Package 60cm	10 Times on Wood Floor	Electrically Functional
		With Package 60cm	10 Times on Wood Floor	Electrically Functional
	Vibration Test	50Hz X-Axis 2mm 30min	Vibration Table	Electrically Functional
		50Hz Y-Axis 2mm 30min	Vibration Table	Electrically Functional
		50Hz Z-Axis 2mm 30min	Vibration Table	Electrically Functional
	Cable Tensile Strength Test	Loading Weight 4 kg 60 Seconds Cycling in 24 Hours	Tensile Testing Machine	Electrically Functional
Electrical	ESD Test	Contact Discharge 2 KV	ESD Testing Machine	Electrically Functional
		Air Discharge 4 KV	ESD Testing Machine	Electrically Functional
	Aging Test	On/Off 30 Seconds Cycling in 24 Hours	Power Switch	Electrically Functional
	USB Connector	On/Off 250 Times	Plug and Unplug	Electrically Functional



Camera Inspection Standard

Inspection Item		Inspection Method	Standard of Inspection		
Category	Item				
Appearance	FPC/ PCB	Color	The Naked Eye	Major Difference is Not Allowed.	
		Be Torn/Chopped	The Naked Eye	Copper Crack Exposure is Not Allowed.	
		Marking	The Naked Eye	Clear, Recognizable (Within 30cm Distance)	
	Holder	Scratches	The Naked Eye	The Inside Crack Exposure is Not Allowed	
		Gap	The Naked Eye	Meet the Height Standard	
		Screw	The Naked Eye	Make Sure Screws Are Presented (If Any)	
		Damage	The Naked Eye	The Inside Crack Exposure is Not Allowed	
	Lens	Scratch	The Naked Eye	No Effect On Resolution Standard	
		Contamination	The Naked Eye	No Effect On Resolution Standard	
		Oil Film	The Naked Eye	No Effect On Resolution Standard	
		Cover Tape	The Naked Eye	No Issue On Appearance.	
	Function	Image	No Communication	Test Board	Not Allowed
			Bright Pixel	Black Board	Not Allowed In the Image Center
Dark Pixel			White board	Not Allowed In the Image Center	
Blurry			The Naked Eye	Not Allowed	
No Image			The Naked Eye	Not Allowed	
Vertical Line			The Naked Eye	Not Allowed	
Horizontal Line			The Naked Eye	Not Allowed	
Light Leakage			The Naked Eye	Not Allowed	
Blinking Image			The Naked Eye	Not Allowed	
Bruise			Inspection Jig	Not Allowed	
Resolution			Chart	Follows Outgoing Inspection Chart Standard	
Color			The Naked Eye	No Issue	
Noise			The Naked Eye	Not Allowed	
Corner Dark			The Naked Eye	Less Than 100px By 100px	
Color Resolution			The Naked Eye	No Issue	
Dimension	Height	The Naked Eye	Follows Approval Data Sheet		
	Width	The Naked Eye	Follows Approval Data Sheet		
	Length	The Naked Eye	Follows Approval Data Sheet		
	Overall	The Naked Eye	Follows Approval Data Sheet		

YDSCAM Package Solutions

YDS Camera Module



Complete with Lens Protection Film



Tray with Grid and Space



Place Cameras on the Tray

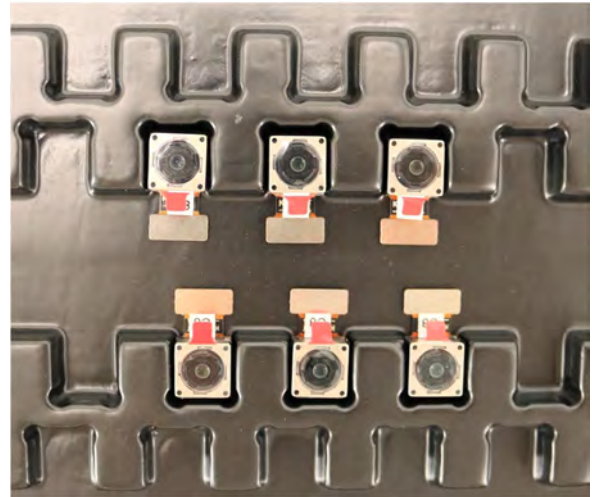

YDSCAM Package Solutions

Full Tray of Cameras

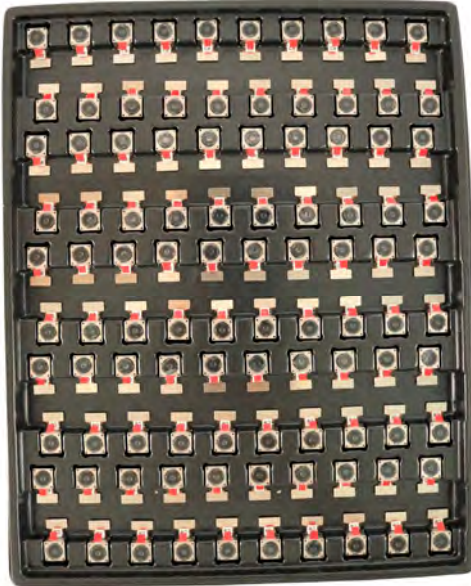

Cover Tray with Lid

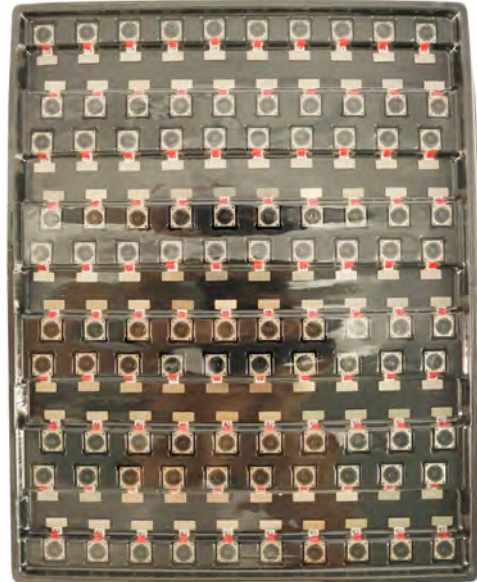

Place Tray into Anti-Static Bag



Vacuum the Anti-Static Bag



YDSCAM Package Solutions

Sealed Vacuum Anti-Static Bag with Labels

1. Model and Description 2. Quantity 3. Manufacturing Date Code 4. Caution



YDSCAM Package Solutions

Place Foam Sheets Between Tray Bags



Foam Sheets are Larger Than Trays



Place Foam Sheets and Trays into Box



Foam Sheets are Tightly Fitting in Box



Seal the Carbon Box



Label the Carbon Shipping Box





YDSCAM Package Solutions

USB Camera Module

Complete with Lens Protection Film

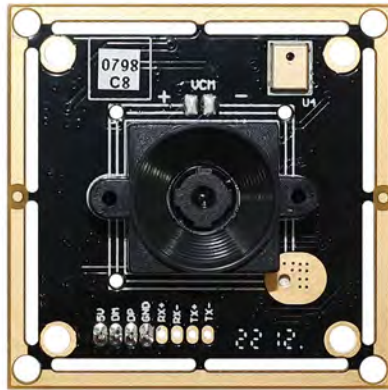

Place Camera Sample into Anti-Static Bag

Place USB Cameras into Tray



Seal the Tray with Anti-Static Bag

Label the Carbon Shipping Box



YDSCAM Package Solutions

Place Camera Sample into Anti-Static Bag



Place Connectors into Anti-Static Bag



Label the Sample Bags



Place Connectors into Reel



Place Samples into the Carbon Box



Place Connectors into the Carbon Box





YDS CAMERA MODULE

your best camera partner

Company YDSCAM

YingDeShun Co. Ltd. (YDS) was established in 2017, a next-generation technology driven manufacturer specialized in research, design, and produce of audio and video products. YDS is occupying 20,000 square feet automated plants with 100 employees of annual throughput 30,000,000 units cameras.

YDS provides OEM, ODM design, contract manufacturing, and builds the camera products. You may provide the requirements to us, even with a hand draft, our sales and engineering work together to meet your needs. We consider ourselves your last-term partner in developing practical and innovative solutions.

Our team covers everything from initial concept development to mass produced product. YDS specializes in customized camera design, raw material, electronic engineering, firmware/software development, product testing, and packing design. Our experienced strategic supply systems offer a robust and dependable manufacturing capacity for orders of various sizes.

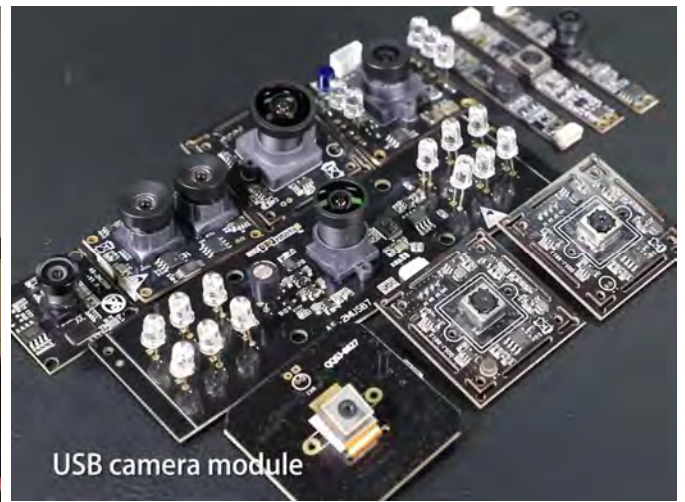

Limited Warranty

YDS provides the following limited warranty if you purchased the Product(s) directly from YDS company or from YDS's website www.YDSCAM.com. Product(s) purchased from other sellers or sources are not covered by this Limited Warranty. YDS guarantees that the Product(s) will be free from defects in materials and workmanship under normal use for a period of one (1) year from the date you receive the product ("Warranty Period").

For all Product(s) that contain or develop material defects in materials or workmanship during the Warranty Period, YDS will, at its sole option, either: (i) repair the Product(s); (ii) replace the Product(s) with a new or refurbished Product(s) (replacement Product(s) being of identical model or functional equivalent); or (iii) provide you a refund of the price you paid for the Product(s).

This Limited Warranty of YDS is solely limited to repair and/or replacement on the terms set forth above. YDS is not reliable or responsible for any subsequent events.



www.YDSCAM.com sales@ydscom.com Phone (WeChat, QQ): (+86) 177 2732 6718

All rights reserved @ YingDeShun Co. Ltd. Specifications subject to change without notice.



YDS CAMERA MODULE

your best camera partner

YDS Strength

Powerful Factory



Professional Service



Promised Delivery



www.YDSCAM.com sales@ydscam.com Phone (WeChat, QQ): (+86) 177 2732 6718

All rights reserved @ YingDeShun Co. Ltd. Specifications subject to change without notice.